

CrazyDrill™ Crosspilot

Mikron Tool 

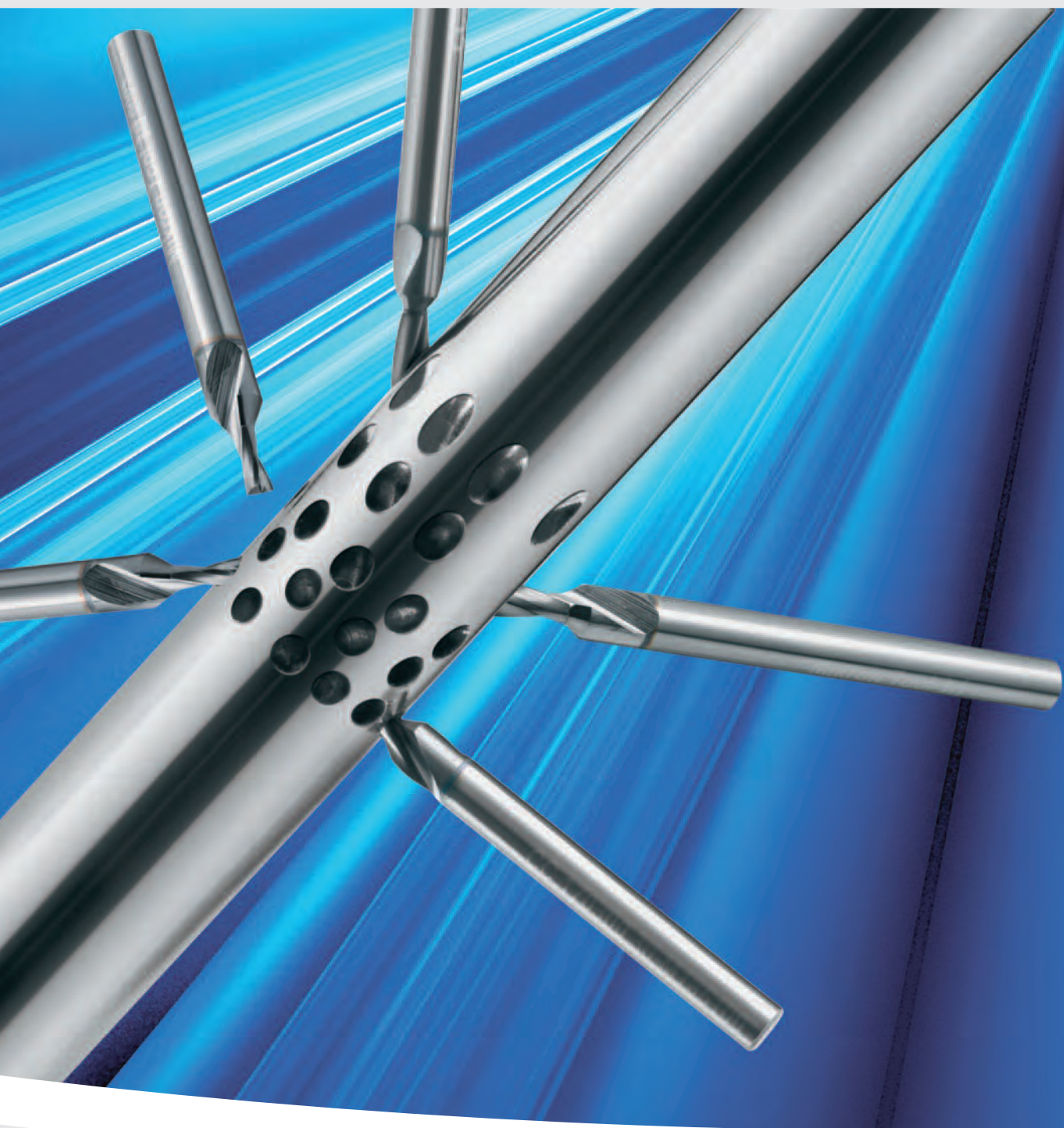

Precision on inclined surfaces

CRAZYDRILL™
by Mikron Tool
Crosspilot

Outstanding centering

Machining of inclined holes with traditional method

Milling tool

Step 1:

- Flat milling

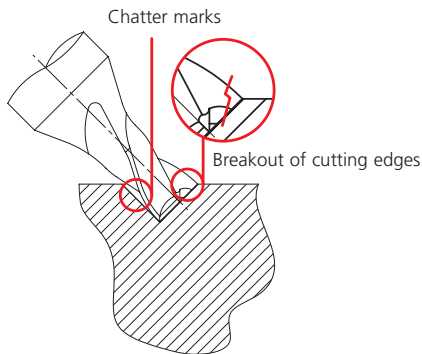

NC spot drill

Step 2:

- Centering

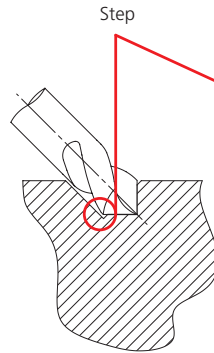

Twist drill

Step 3:

- Drilling

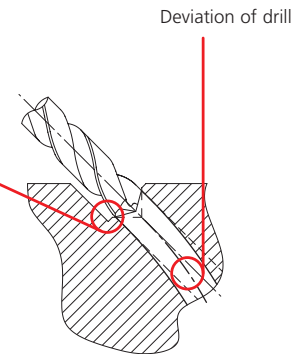

The disadvantages:

- 3 machining operations
- Breakout of cutting edges at the end mill
- Chatter marks caused from end mill
- Step between milled hole and bore
- Deviation of hole due to missing guidance

Inclined hole, performed with CrazyDrill Crosspilot

CRAZYDRILL™
by Mikron Tool
Crosspilot

CrazyDrill Crosspilot

Step 1:

- Inclined spot drilling with CrazyDrill Crosspilot from Mikron Tool

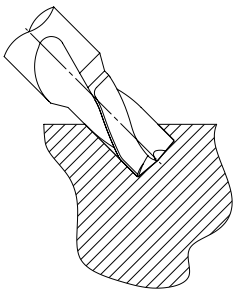

Twist drill

Step 2:

- Long, inclined hole

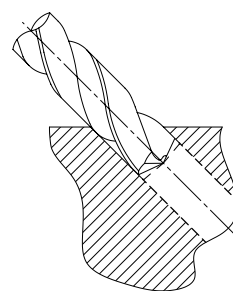

The characteristics:

- Very robust design stands up to lateral forces
- Special tip geometry (170°) guarantees perfect centering for subsequent drill
- Appropriate lead to avoid lateral hooking
- Reinforced, extra long shank assures optimal clamping diameter and access to the work piece

5 convincing advantages:

1. High positioning accuracy
2. High alignment accuracy
3. Using CrazyDrill for subsequent hole creates no difference between pilot hole and bore
4. Saving of 1 tool = saving time
5. Program perfectly matched with other CrazyDrill products

Fields of application

CrazyDrill Crosspilot is used for:



Inclined holes with angle up to 60° on flat surfaces



Inclined holes on convex surfaces

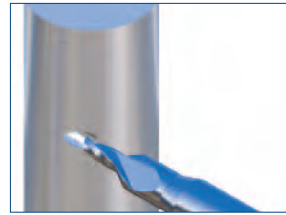

Eccentric holes on convex surfaces



Inclined holes on concave surfaces

The relation between immersion depth and inclination angle

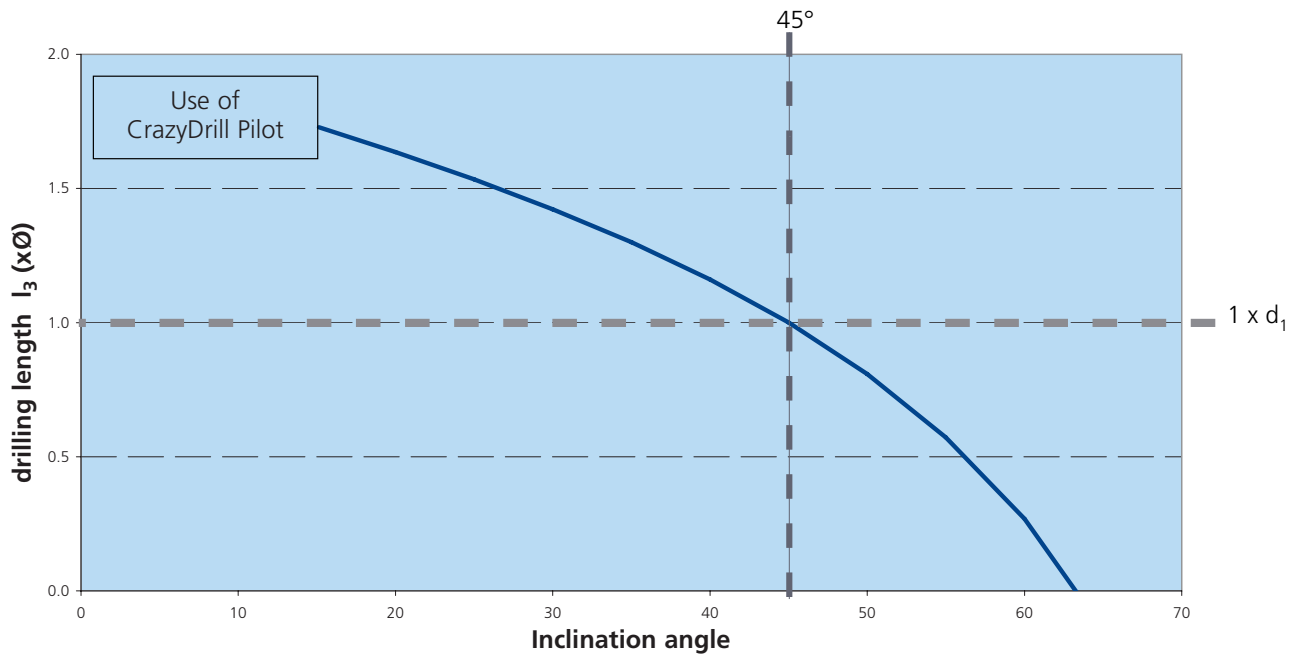

Formula: $l_3 = 2 \times d_1 - d_1 \times (\tan \alpha)$

The hole depth on the short side depends on the inclination angle. Depending on space conditions an inclination of 60° can be achieved.

Example:

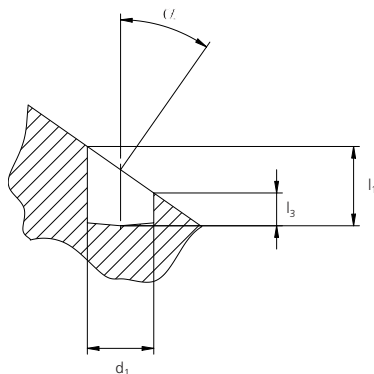

Inclination angle 35°, bore diameter 2mm.
 $2 \times 2 - 2 \text{ mm} (\tan 35^\circ) = 2.6 \text{ mm}$

With an inclination angle of 35° and a depth of 4mm ($2 \times d_1$) on the long side, the hole depth on the short side becomes 2.6mm ($1.3 \times d_1$).

Precision program

Item number	d ₁ (k6) mm	l ₁ mm	d ₂ mm	l ₂ mm	D (H6) mm	L mm
PD.00400.170	0.40	1.000	1.0	2.8	4	50
PD.00450.170	0.45	1.125	1.0	3.0	4	50
PD.00500.170	0.50	1.250	1.2	3.4	4	50
PD.00550.170	0.55	1.375	1.2	3.5	4	50
PD.00600.170	0.60	1.500	1.5	4.3	4	50
PD.00650.170	0.65	1.625	1.5	4.4	4	50
PD.00700.170	0.70	1.750	1.5	4.5	4	50
PD.00750.170	0.75	1.875	1.5	4.6	4	50
PD.00800.170	0.80	2.000	1.7	5.2	4	50
PD.00850.170	0.85	2.125	1.7	5.3	4	50
PD.00900.170	0.90	2.250	1.7	5.4	4	50
PD.00950.170	0.95	2.375	1.7	5.5	4	50
PD.01000.170	1.00	2.500	2.0	6.1	4	55
PD.01050.170	1.05	2.625	2.0	6.2	4	55
PD.01100.170	1.10	2.750	2.0	6.4	4	55
PD.01150.170	1.15	2.875	2.0	6.5	4	55
PD.01200.170	1.20	3.000	2.0	6.6	4	55
PD.01250.170	1.25	3.125	2.5	7.6	4	55
PD.01300.170	1.30	3.250	2.5	7.7	4	55
PD.01350.170	1.35	3.375	2.5	7.8	4	55
PD.01400.170	1.40	3.500	2.5	7.9	4	55
PD.01450.170	1.45	3.625	2.5	8.0	4	55
PD.01500.170	1.50	3.750	3.0	9.1	4	55
PD.01550.170	1.55	3.875	3.0	9.2	4	55
PD.01600.170	1.60	4.000	3.0	9.3	4	55
PD.01650.170	1.65	4.125	3.0	9.4	4	55
PD.01700.170	1.70	4.250	3.0	9.6	4	55
PD.01750.170	1.75	4.375	3.0	9.7	4	55
PD.01800.170	1.80	4.500	3.5	10.6	4	55
PD.01850.170	1.85	4.625	3.5	10.8	4	55
PD.01900.170	1.90	4.750	3.5	10.9	4	55
PD.01950.170	1.95	4.875	3.5	11.0	4	55
PD.02000.170	2.00	5.000	3.5	11.1	6	65
PD.02050.170	2.05	5.125	3.5	11.2	6	65
PD.02100.170	2.10	5.250	3.5	11.3	6	65
PD.02150.170	2.15	5.375	3.5	11.4	6	65
PD.02200.170	2.20	5.500	4.5	13.3	6	65
PD.02250.170	2.25	5.625	4.5	13.4	6	65
PD.02300.170	2.30	5.750	4.5	13.5	6	65
PD.02350.170	2.35	5.875	4.5	13.6	6	65
PD.02400.170	2.40	6.000	4.5	13.7	6	65
PD.02450.170	2.45	6.125	4.5	13.9	6	65
PD.02500.170	2.50	6.250	4.5	14.0	6	65
PD.02550.170	2.55	6.375	4.5	14.1	6	65
PD.02600.170	2.60	6.500	4.5	14.2	6	65
PD.02650.170	2.65	6.625	5.0	15.2	6	65
PD.02700.170	2.70	6.750	5.0	15.3	6	65
PD.02750.170	2.75	6.875	5.0	15.4	6	65
PD.02800.170	2.80	7.000	5.0	15.5	6	65
PD.02850.170	2.85	7.125	5.0	15.6	6	65
PD.02900.170	2.90	7.250	5.0	15.7	6	65
PD.02950.170	2.95	7.375	5.0	15.9	6	65
PD.03000.170	3.00	7.500	-	-	6	70
PD.03050.170	3.05	7.625	-	-	6	70
PD.03100.170	3.10	7.750	-	-	6	70
PD.03150.170	3.15	7.875	-	-	6	70
PD.03200.170	3.20	8.000	-	-	6	70
PD.03250.170	3.25	8.125	-	-	6	70
PD.03300.170	3.30	8.250	-	-	6	70
PD.03350.170	3.35	8.375	-	-	6	70
PD.03400.170	3.40	8.500	-	-	6	70
PD.03450.170	3.45	8.625	-	-	6	70
PD.03500.170	3.50	8.750	-	-	6	70
PD.03550.170	3.55	8.875	-	-	6	70
PD.03600.170	3.60	9.000	-	-	6	70
PD.03650.170	3.65	9.125	-	-	6	70
PD.03700.170	3.70	9.250	-	-	6	70
PD.03750.170	3.75	9.375	-	-	6	70
PD.03800.170	3.80	9.500	-	-	6	70
PD.03850.170	3.85	9.625	-	-	6	70
PD.03900.170	3.90	9.750	-	-	6	70
PD.03950.170	3.95	9.875	-	-	6	70
PD.04000.170	4.00	10.000	-	-	6	70
PD.04100.170	4.10	10.250	-	-	6	70
PD.04200.170	4.20	10.500	-	-	6	70
PD.04300.170	4.30	10.750	-	-	6	70
PD.04400.170	4.40	11.000	-	-	6	70
PD.04500.170	4.50	11.250	-	-	8	80
PD.04600.170	4.60	11.500	-	-	8	80
PD.04700.170	4.70	11.750	-	-	8	80
PD.04800.170	4.80	12.000	-	-	8	80
PD.04900.170	4.90	12.250	-	-	8	80
PD.05000.170	5.00	12.500	-	-	8	80
PD.05100.170	5.10	12.750	-	-	8	80
PD.05200.170	5.20	13.000	-	-	8	80
PD.05300.170	5.30	13.250	-	-	8	80
PD.05400.170	5.40	13.500	-	-	8	80
PD.05500.170	5.50	13.750	-	-	8	80
PD.05600.170	5.60	14.000	-	-	8	80
PD.05700.170	5.70	14.250	-	-	8	80
PD.05800.170	5.80	14.500	-	-	8	80
PD.05900.170	5.90	14.750	-	-	8	80
PD.06000.170	6.00	15.000	-	-	8	80

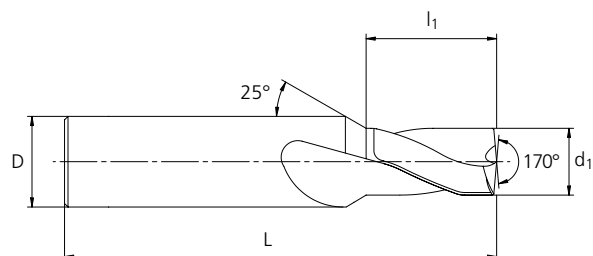
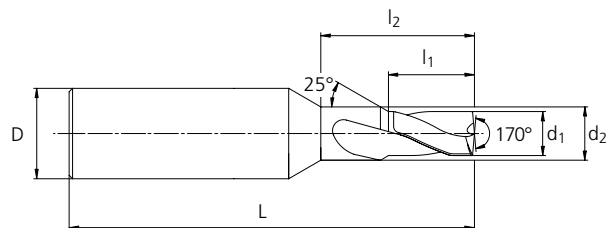

CRAZYDRILL™
by Mikron Tool
Crosspilot



All CrazyDrill Crosspilot are coated

Guidelines for cutting parameters

CRAZYDRILL™
by Mikron Tool
Crosspilot

Materials to be machined	Examples	Cutting speed vc m/min	Feed f in mm/revolution in relation to diameter (indicative)								
			0.4 mm	0.8 mm	1.0 mm	1.5 mm	2.0 mm	3.0 mm	4.0 mm	5.0 mm	6.0 mm
Low-alloy steels	Ck45, 16MnCr5, 20MnCr6	80	0.005	0.011	0.013	0.020	0.027	0.040	0.053	0.067	0.080
Low-alloy tool steels	100Cr6, 90MnCrV8	60	0.004	0.008	0.010	0.015	0.020	0.030	0.040	0.050	0.060
High-alloy steels	G-X 100 CrMoV 5 1, X210CeW12, S 18-1-2-10	50	0.004	0.008	0.010	0.015	0.020	0.030	0.040	0.050	0.060
Steels with hardness >50HRC	90MnCrV8, X40CrV5-1	20	0.001	0.003	0.003	0.005	0.007	0.010	0.013	0.017	0.020
Ferritic Inox steels	X17CrNi16-2, X6CrMo 17-1, X20Cr13, G-X130CrSi29	40	0.002	0.004	0.005	0.008	0.010	0.015	0.020	0.025	0.030
Austenitic Inox steels	X5CrNi 18-10	30	0.002	0.004	0.005	0.008	0.010	0.015	0.020	0.025	0.030
Cast iron	GG20 - GG50; GGG40 - GGG70	80	0.004	0.008	0.010	0.015	0.020	0.030	0.040	0.050	0.060
Titanium and Titanium alloys	Ti.Gr2, Ti.Gr.5	25	0.004	0.008	0.010	0.015	0.020	0.030	0.040	0.050	0.060
Aluminum alloy, wrought	6061-T6, AlCuMg1, Certal	125	0.008	0.016	0.020	0.030	0.040	0.060	0.080	0.100	0.120
Copper alloy, easy machinable	G-AlSi9Cu3, G-AlSi7Mg	125	0.008	0.016	0.020	0.030	0.040	0.060	0.080	0.100	0.120
Copper alloy, easy machinable	CuZn39Pb2	100	0.008	0.016	0.020	0.030	0.040	0.060	0.080	0.100	0.120
Copper alloy, difficult to machine	Cu, CuZn10, CuZn30, CuNi18Zn20	80	0.004	0.008	0.010	0.015	0.020	0.030	0.040	0.050	0.060

This data is indicative. Different conditions due to machine, spindle, coolant, etc. can influence the performance.

Important criteria:

For best results Mikron Tool recommends the use of cutting oil as lubricant. The use of water based coolant, or minimum quantity lubrication is also possible as an alternative. In this case the cutting parameters have to be adjusted accordingly.

Services that complete the concept

Engineering and Consulting

Mikron Tool advises its customers on the selection of suitable tools with respect to material and geometry, necessary tolerances and ideal operating parameters, and partners with them from the initial trials through mass production.

Star-Service

With the Star Service (Standard Tool Adjustment & Record Service), Mikron Tool also offers high-performance drills in dimensions outside the standard range.

Regrinding

CrazyDrill with a diameter of 1.5 mm or more can be reground and recoated which considerably increases the cost-effectiveness of this drill. Mikron Tool offers this service in Agno (Switzerland) as well as in Rottweil (Germany).

Packaging

Practical packaging provides optimum protection for the tool and allows easier, safer handling without the risk of personal injury or tool damage.

Recycling

Worn tools (CrazyDrill and special tools) are taken back by Mikron Tool, and the material is recycled – holding true our statement in our environmental certificate.

Certifications

Mikron Tool is certified to:
 ISO 9001:2000 for quality
 ISO 14001:2004 for environment
 OHSAS 18001:1999 for occupational health and safety management.

CrazyDrill products are supplied with a Quality Certificate and an instruction for safe handling.



High performance tools from Mikron Tool

CrazyDrill: for large production lots and materials difficult to machine.

CrazyDrill is ideally suited for high volume production of precision parts. CrazyDrill offers, comparing to standard drills, much higher cutting speeds and feeds.



MiquDrill: for smaller production lots and a variety of work pieces

Mikron Tool standard quality drills MiquDrill are the perfect solution for the machining of small to midsize work pieces, guaranteeing at the same time quality and process reliability.



Special tools: customer tailored solutions for machining of precision parts

Developed for particular machining operations; special tools guarantee the best conditions for a process-sure, efficient machining of precision parts.

Special tools

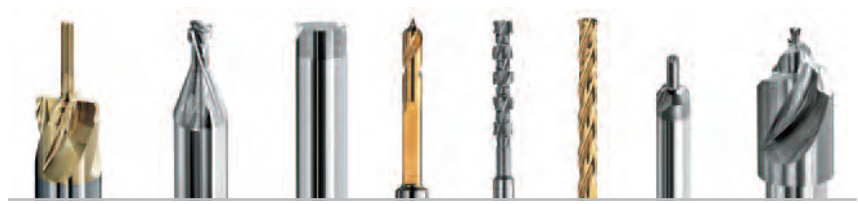

Your contacts

Headquarter and Production:

Mikron Tool SA Agno
P.O. Box 340
6934 Bioggio
Switzerland
Phone +41 91 610 40 00
Fax +41 91 610 40 10
mto@mikron.com

Production for Germany
and Regrinding EU:

Mikron GmbH Rottweil
Abteilung Werkzeuge
Bernler Feld 71
78628 Rottweil
Germany
Phone +49 741 5380 450
Fax +49 741 5380 480
info.mtr@mikron.com

Japan:

Mikron Ltd. Tokyo
Shin-Yokohama, Kohoku-Ku
Yokohama City 222-0033
Japan
Phone +81 45 472 10 01
Fax +81 45 472 20 22
mfe@mikron.com

North and South America Sales:

Mikron Corp. Monroe
P.O. Box 268
600 Pepper Street
Monroe, CT 06468
USA
Phone +1 203 261 3100
Fax +1 203 268 4752
mmo@mikron.com

